

**EN ORIGINAL INSTRUCTIONS**

**IMPORTANT** - These instructions are for your safety.  
Please read through them thoroughly prior to handling  
the product and retain them for future reference.



# EN Parts

---

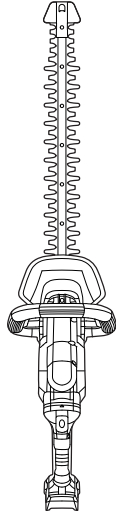

01. x1



02. x1

# EN You will need

---

x1



# EN Contents

<b>EN</b>	
<b>Product description</b>	<b>3</b>
<b>Safety</b>	<b>4</b>
<b>Technical specification</b>	<b>18</b>
<b>Before you start</b>	<b>19</b>
<b>Functions &amp; Settings</b>	<b>22</b>
<b>Operation</b>	<b>25</b>
<b>Care and maintenance</b>	<b>27</b>
<b>Guarantee</b>	<b>31</b>
<b>Declaration of conformity</b>	<b>33</b>

# EN Product Description

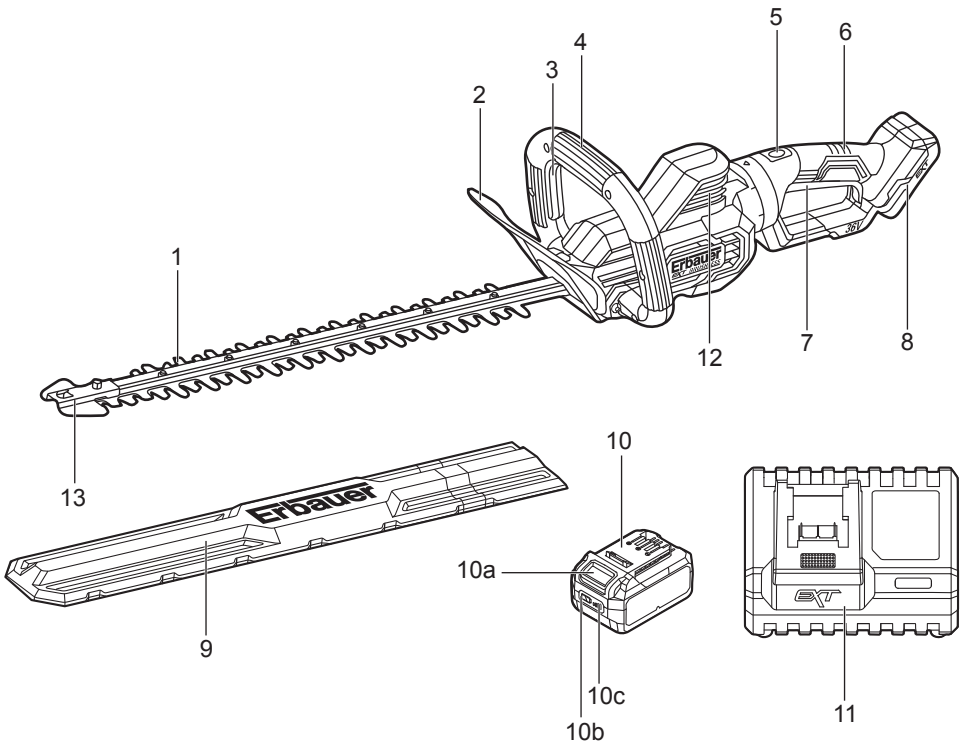

- |    |                      |      |                        |
|----|----------------------|------|------------------------|
| 1. | Blade                | 9.   | Blade cover            |
| 2. | Hand guard           | 10*. | Battery pack           |
| 3. | Front trigger        | a.   | Battery release button |
| 4. | Front handle         | b.   | Power bar button       |
| 5. | Head lock button     | c.   | Power bar              |
| 6. | Rear handle          | 11*. | Charger                |
| 7. | Rear trigger         | 12.  | Air vents              |
| 8. | Battery docking port | 13.  | Tip protector          |

**NOTE:** \* This may not be included in the supply scope.



## General power machine safety warnings



**WARNING!** Read all safety warnings, instructions, illustrations and specifications provided with this machine. *Failure to follow all instructions listed below may result in electric shock, fire and/or serious injury.*

**Save all warnings and instructions for future reference.**

*The term “machine” in the warnings refers to your mains-operated (corded) machine or battery-operated (cordless) machine.*

## Work area safety

- a) **Keep work area clean and well lit.** *Cluttered or dark areas invite accidents.*
- b) **Do not operate machines in explosive atmospheres, such as in the presence of flammable liquids, gases or dust.** *Machines create sparks which may ignite the dust or fumes.*
- c) **Keep children and bystanders away while operating a machine.** *Distractions can cause you to lose control.*

## Electrical safety

- a) **Machine plugs must match the outlet. Never modify the plug in any way. Do not use any adapter plugs with earthed (grounded) machines.** *Unmodified plugs and matching outlets will reduce risk of electric shock.*

- b) **Avoid body contact with earthed or grounded surfaces such as pipes, radiators, ranges and refrigerators.** *There is an increased risk of electric shock if your body is earthed or grounded.*
- c) **Do not expose machines to rain or wet conditions.** *Water entering a machine will increase the risk of electric shock.*
- d) **Do not abuse the cord. Never use the cord for carrying, pulling or unplugging the machine. Keep cord away from heat, oil, sharp edges or moving parts.** *Damaged or entangled cords increase the risk of electric shock.*
- e) **When operating a machine outdoors, use an extension cord suitable for outdoor use.** *Use of a cord suitable for outdoor use reduces the risk of electric shock.*
- f) **If operating a machine in a damp location is unavoidable, use a residual current device (RCD) protected supply.** *Use of an RCD reduces the risk of electric shock.*

## **Personal safety**

- a) **Stay alert, watch what you are doing and use common sense when operating a machine. Do not use a machine while you are tired or under the influence of drugs, alcohol or medication.** *A moment of inattention while operating machines may result in serious personal injury.*

- b) **Use personal protective equipment. Always wear eye protection.** *Protective equipment such as a dust mask, non-skid safety shoes, hard hat, or hearing protection used for appropriate conditions will reduce personal injuries.*
- c) **Prevent unintentional starting. Ensure the switch is in the off-position before connecting to power source and/or battery pack, picking up or carrying the machine.** *Carrying machines with your finger on the switch or energising machines that have the switch on invites accidents.*
- d) **Remove any adjusting key or wrench before turning the machine on.** *A wrench or a key left attached to a rotating part of the machine may result in personal injury.*
- e) **Do not overreach. Keep proper footing and balance at all times.** *This enables better control of the machine in unexpected situations.*
- f) **Dress properly. Do not wear loose clothing or jewellery. Keep your hair and clothing away from moving parts.** *Loose clothes, jewellery or long hair can be caught in moving parts.*
- g) **If devices are provided for the connection of dust extraction and collection facilities, ensure these are connected and properly used.** *Use of dust collection can reduce dust-related hazards.*
- h) **Do not let familiarity gained from frequent use of machines allow you to become complacent and ignore machine safety principles.** *A careless action can cause severe injury within a fraction of a second.*

## Machine use and care

- a) **Do not force the machine. Use the correct machine for your application.** *The correct machine will do the job better and safer at the rate for which it was designed.*
- b) **Do not use the machine if the switch does not turn it on and off.** *Any machine that cannot be controlled with the switch is dangerous and must be repaired.*
- c) **Disconnect the plug from the power source and/ or remove the battery pack, if detachable, from the machine before making any adjustments, changing accessories, or storing machines.** *Such preventive safety measures reduce the risk of starting the machine accidentally.*
- d) **Store idle machines out of the reach of children and do not allow persons unfamiliar with the machine or these instructions to operate the machine.** *Machines are dangerous in the hands of untrained users.*
- e) **Maintain machines and accessories. Check for misalignment or binding of moving parts, breakage of parts and any other condition that may affect the machine's operation. If damaged, have the machine repaired before use.** *Many accidents are caused by poorly maintained machines.*
- f) **Keep cutting tools sharp and clean.** *Properly maintained cutting tools with sharp cutting edges are less likely to bind and are easier to control.*

- g) Use the machine, accessories and tool bits etc., in accordance with these instructions, taking into account the working conditions and the work to be performed. *Use of the machine for operations different from those intended could result in a hazardous situation.***
- h) Keep handles and grasping surfaces dry, clean and free from oil and grease. *Slippery handles and grasping surfaces do not allow for safe handling and control of the machine in unexpected situations.***

### **Battery machine use and care**

- a) Recharge only with the charger specified by the manufacturer. *A charger that is suitable for one type of battery pack may create a risk of fire when used with another battery pack.***
- b) Use machines only with specifically designated battery packs. *Use of any other battery packs may create a risk of injury and fire.***
- c) When battery pack is not in use, keep it away from other metal objects, like paper clips, coins, keys, nails, screws, or other small metal objects, that can make a connection from one terminal to another. *Shorting the battery terminals together may cause burns or a fire.***
- d) Under abusive conditions, liquid may be ejected from the battery; avoid contact. If contact accidentally occurs, flush with water. If liquid contacts eyes, additionally seek medical help. *Liquid ejected from the battery may cause irritation or burns.***

- e) **Do not use a battery pack or machine that is damaged or modified.** *Damaged or modified batteries may exhibit unpredictable behaviour resulting in fire, explosion or risk of injury.*
- f) **Do not expose a battery pack or machine to fire or excessive temperature.** *Exposure to fire or temperature above 130°C may cause explosion.*
- g) **Follow all charging instructions and do not charge the battery pack or machine outside the temperature range specified in the instructions.** *Charging improperly or at temperatures outside the specified range may damage the battery and increase the risk of fire.*

## **Service**

- a) **Have your machine serviced by a qualified repair person using only identical replacement parts.** *This will ensure that the safety of the machine is maintained.*
- b) **Never service damaged battery packs.** *Service of battery packs should only be performed by the manufacturer or authorized service providers.*

## **Hedge trimmer safety warnings**

- a) **Do not use the hedge trimmer in bad weather conditions, especially when there is a risk of lightning.** *This decreases the risk of being struck by lightning.*
- b) **Keep all power cords and cables away from cutting area.** *Power cords or cables may be hidden in hedges or bushes and can be accidentally cut by the blade.*

- c) **Wear ear protection.** *Adequate protective equipment will reduce the risk of hearing loss.*
- d) **Hold the hedge trimmer by insulated gripping surfaces only, because the blade may contact hidden wiring.** *Blades contacting a "live" wire may make exposed metal parts of the hedge trimmer "live" and could give the operator an electric shock.*
- e) **Keep all parts of the body away from the blade. Do not remove cut material or hold material to be cut when blades are moving.** *Blades continue to move after the switch is turned off. A moment of inattention while operating the hedge trimmer may result in serious personal injury.*
- f) **When clearing jammed material or servicing the hedge trimmer, make sure all power switches are off and the battery pack is removed or disconnected.** *Unexpected actuation of the hedge trimmer while clearing jammed material or servicing may result in serious personal injury.*
- g) **Carry the hedge trimmer by the handle with the blade stopped and taking care not to operate any power switch.** *Proper carrying of the hedge trimmer will decrease the risk of inadvertent starting and resultant personal injury from the blades.*
- h) **When transporting or storing the hedge trimmer, always use the blade cover.** *Proper handling of the hedge trimmer will decrease the risk of personal injury from the blades.*

## **Additional safety warnings for hedge trimmer**

- a) *Do not grasp the exposed cutting blades or cutting edges when picking up or holding the hedge trimmer.*
- b) *Do not use on a ladder, rooftop, tree, or other unstable support. Stable footing on a solid surface enables better control of the hedge trimmer in unexpected situations.*
- c) *Never allow children to operate the hedge trimmer.*
- d) *Never remove or tamper with safety devices. Check their proper operation regularly. Never do anything to interfere with the intended function of a safety device or to reduce the protection provided by a safety device.*
- e) *Never operate the hedge trimmer without proper guards, plates, or other safety protective devices in place.*
- f) *Check damaged parts before further use of the hedge trimmer. A guard or other part that is damaged should be carefully checked to determine that it will operate properly and perform its intended function. Check for alignment of moving parts, binding of moving parts, breakage of parts, mounting, and any other condition that may affect its operation. A guard or other part that is damaged should be properly repaired or replaced by an authorized service center unless indicated elsewhere in this manual.*
- g) *Check the blade and motor mounting bolts at frequent intervals for proper tightness. Also, visually inspect blade for damage (e.g., bent, cracked, and worn). Replace the blade only with a blade from the original equipment manufacturer.*

- h) *Replace the blade if it is bent or cracked. An unbalanced blade causes vibration that could damage the motor drive unit or cause personal injury.*
- i) *If the equipment should start to vibrate abnormally, stop the motor and check immediately for the cause. Vibration is generally a warning of trouble.*
- j) *The trimmer shall be used to cut stems less than 30 mm thick.*
- k) *Trim only in daylight or in good artificial light.*
- l) *Remove or disconnect battery before servicing, cleaning, or removing material from the hedge trimmer.*
- m) *Do not wash with a hose; avoid getting water in motor and electrical connections.*
- n) *When servicing use only identical replacement parts listed in this manual. Use of parts which do not meet the original equipment specifications may lead to improper performance and compromised safety.*
- o) *Do not incinerate the appliance even if it is severely damaged. The batteries can explode in a fire.*
- p) *Follow instructions for lubricating and changing accessories.*
- q) *Keep handles dry, clean and free from oil and grease.*
- r) *Check the hedges and bushes for foreign objects, e.g. wire fences and hidden wiring before operating the machine.*
- s) Thoroughly inspect the area for wildlife where the machine is to be used. Wildlife may be injured by the machine during operation.**

## **Additional safety warnings for battery pack**

- a) **Battery pack needs to be charged before use.** *Always refer to the charger's instruction and charge it properly.*
- b) **Remove the battery pack from the product when not in use.**
- c) **Don't maintain the battery pack on the charger when not in use.**
- d) **After extended periods of storage, it may be necessary to charge and discharge the battery pack several times to obtain the maximum performance.**
- e) **Longer life and better performance can be obtained if the battery is charged when the air temperature is between 18°C and 24°C.** *Do not charge the battery in air temperature below 5°C or above 40°C. This is important as it can prevent serious damage to the battery.*
- f) **Do not charge battery in a damp or wet location.** *Following this rule will reduce the risk of electric shock.*
- g) **Do not disassemble the battery and avoid mechanical damage to the battery. Risk of short circuit and fumes may be emitted.** *Ensure fresh air and seek medical assistance in the event of discomfort.*
- h) **When disposing of battery pack, keep the battery pack of different electrochemical systems separate from each other.**

## **Vibration and noise reduction**

To reduce the impact of noise and vibration emission, limit the time of operation, use low-vibration and low- noise operating modes as well as wear personal protective equipment.

Take the following points into account to minimize the vibration and noise exposure risks:

1. Only use the product as intended by its design and these instructions.
2. Ensure that the product is in good condition and well maintained.
3. Use correct application tools for the product and ensure they in good condition.
4. Keep tight grip on the handles/grip surface.
5. Maintain this product in accordance with these instructions and keep it well lubricated (where appropriate).
6. Plan your work schedule to spread any high vibration tool use across a longer period of time.
7. Prolonged use of the product exposes the user to vibrations that can cause a range of conditions collectively known as hand-arm vibration syndrome (HAVS) e.g. fingers going white; as well as specific diseases such as carpal tunnel syndrome. To reduce this risk when using the product, always wear protective gloves and keep your hands warm.

## **Emergency**

**Familiarise yourself with the use of this product by means of this instruction manual. Memorise the safety directions and follow them to the letter. This will help to prevent risks and hazards.**

1. **Always be alert when using this product, so that you can recognise and handle risks early.** *Fast intervention can prevent serious injury and damage to property.*

2. **Switch off and disconnect from the power supply if there are malfunctions.** *Have the product checked by a qualified professional and repaired, if necessary, before you operate it again.*

## **Residual risks**

**Even if you are operating this product in accordance with all the safety requirements, potential risks of injury and damage remain. The following dangers can arise in connection with the structure and design of this product:**

1. Health defects resulting from vibration emission if the product is being used over long periods of time or not adequately managed and properly maintained.
2. Injuries and damage to property due to broken accessories or the sudden impact of hidden objects during use.
3. Danger of injury and property damage caused by flying objects.



**WARNING!** This product produces an electromagnetic field during operation! This field may under some circumstances interfere with active or passive medical implants! To reduce the risk of serious or fatal injury, we recommend persons with medical implants to consult their doctor and the medical implant manufacturer before operating this product!

# Symbols

On the product, the rating label and within these instructions you will find among others the following symbols and abbreviations. Familiarise yourself with them to reduce hazards like personal injuries and damage to property.

V 	Volt, (direct current voltage)	km/h	Kilometre/Per hour
mAh	Milliampere per hour	mm	Millimetre
m	Metre	kg	Kilogram
l	Litre	m/s <sup>2</sup>	Metres per second squared
cm <sup>3</sup>	Cubic centimetre	dB(A)	Decibel (A-rated)
yyWxx	Manufacturing date code: year of manufacturing (20yy) and week of manufacturing (Wxx).		



Read the instruction manual



Caution / Warning.



Note / Remark.



Wear eye protection



Wear ear protection



Wear safety footwear



Wear protective gloves



Wear protective clothing



Use appropriate protection for foot-leg and hand-arm.



Wear a mask



Objects thrown by the product could hit the user or other bystanders. Always ensure that other people and pets remain at a safe distance from the product when it is in operation. In general, children must not come near the area where the product is. Minimum distance 15m.



Do not use in rain or wet conditions.



Keep hands away from moving cutting device!



Guaranteed sound power level value in XX dB(A).



WEEE symbol. Waste electrical products should not be disposed of with household waste. Please recycle where facilities exist. Check with your Local Authority or local store for recycling advice.



Crossed out dust bin. Batteries and battery packs should not be disposed of with household waste. Please recycle where facilities exist. Check with your Local Authority or local store for recycling advice



Do not dispose of battery packs in rivers or immerse in water.



Do not dispose of battery packs in fire. They will explode and cause injury.



Do not expose battery packs to heat in excess of 40 °C.

Do not charge or store the battery pack in temperatures below 5 °C (41 °F) and above 40 °C (104°F).



The product complies with the applicable Your product European directives and an evaluation method of conformity for these directives was done.



UK Conformity Assessed.

## Rating label explanation

Cordless Hedge Trimmer: ERT1027GHT

ER = Brand name (Erbauer)

T = 36V Lithium-Ion

1027 = Serial number

GHT =Garden Hedge trimmer

# EN Technical specifications

## General:

> Rated voltage	36V $\overline{\text{---}}$
> Rated no load speed $n_0$	1,500/min
> Blade length	60 cm
> Cutting length	53 cm
> Cutting capacity	30 mm
> trimmer head pivoting angle	$\pm 45^\circ$ , $0^\circ$ , $+90^\circ$
> Weight (without battery pack)	approx. 3.1 kg

## Battery pack (may not be included)

> Model no.	ERT1044BAT	ERT1045BAT
> Type	Li-Ion	Li-Ion
> Voltage	18 V $\overline{\text{---}}$ / 36 V $\overline{\text{---}}$	18 V $\overline{\text{---}}$ / 36 V $\overline{\text{---}}$
> Capacity	8 Ah / 4Ah	6 Ah / 3 Ah
> Weight	approx. 1.2 kg	approx. 1.2 kg



**NOTE:** This equipment is compatible with the Erbauer EXT 18V/36V dual-voltage lithium-ion battery range. For optimal performance, use 1X 4.0Ah battery.

## Charger for battery pack (may not be included)

> Model no.	ERT1047CHR	ERT1046CHR
> Rated input	220-240 V~ 50 Hz	220-240 V~ 50 Hz
> Rated output	21 V $\overline{\text{---}}$ 12 A	21 V $\overline{\text{---}}$ x2 12 A
> Ambient temperature range for machine, charger and battery use	5°C to 40°C	5°C to 40°C

## Sound values:

> Sound pressure level $L_{pA}$	83dB(A)
> Uncertainty $K_{pA}$	3dB(A)
> Measured sound power level $L_{WA}$	90dB(A)
> Uncertainty $K_{WA}$	1.8dB(A)
> Guaranteed sound power level $L_{WA}$	92dB(A)
> Vibration $a_h$	2.8m/s <sup>2</sup>
> Uncertainty K	1.5m/s <sup>2</sup>

The sound value(s) have been determined according to noise test code given in EN IEC 62841-1 and EN IEC 62841-4-2, using the basic standards EN ISO 11201 and EN ISO 3744. The sound intensity level for the operator may exceed 80 dB(A) and ear protection measures are necessary.

The declared total vibration value(s) and the declared noise emission value(s) have been measured in accordance with a standard test method and may be used for comparing one tool with another;

The declared total vibration value(s) and the declared noise emission value(s) may also be used in a preliminary assessment of exposure.



**WARNING!** The vibration and noise emission during actual use of the power tool can differ from the declared total value depending on the ways in which the tool is used especially what kind of workpiece is processed;

The need to identify safety measures to protect the operator that are based on an estimation of exposure in the actual conditions of use (taking account of all parts of the operating cycle such as the times when the tool is switched off and when it is running idle in addition to the trigger time).



## EN Before you start

---

### Unpacking

1. Unpack all parts and lay them on a flat, stable surface.
2. Remove all packing materials and shipping devices if applicable.
3. Make sure the delivery contents are complete and free of any damage. If you find that parts are missing or show damage do not use the product but contact your dealer. Using an incomplete or damaged product represents a hazard to people and property.
4. Ensure that you have all the accessories and tools needed for assembly and operation. This also includes suitable personal protective equipment.



**WARNING!** The product and the packaging are not children's toys! Children must not play with plastic bags, sheets and small parts! There is a danger of choking and suffocation!

### You will need

#### (items not supplied)

Suitable personal protective equipment  
Lubricant for hedge trimmer blade

#### (items supplied)

Blade cover (9)



**NOTE:** The accessories required depend on the intended application. Ask your dealer for advice.

# EN Assembly

---



**WARNING!** The product must be fully assembled before operation! Do not use a product that is only partly assembled or assembled with damaged parts!



**WARNING!** Disconnect the battery pack from the machine before making any assembly, adjustments, changing accessories, or storing machine. Such preventive safety measures reduce the risk of starting the machine accidentally.



Follow the assembly instructions step-by-step and use the pictures provided as a visual guide to easily assemble the product!

Before using the product, familiarise yourself with the operating features read the entire instruction manual paying particular attention to the safety rules and operating procedures.

Do not connect the product to battery pack before it is completely assembled!

## Battery pack

### Attaching / releasing the battery pack

1. Slide the battery pack into the battery docking port (8) until it is securely locked in position.
2. Depress the battery pack release button (10a) to release and slide the battery pack out from your tool. (Fig. 1)

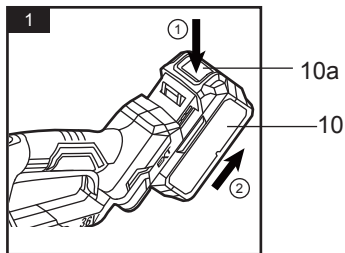

3. After recharge, slide the battery pack back into your tool. A simple push and slight pressure will be sufficient.





## Charging the battery pack

The battery pack for this product has been shipped in a low charge condition. Charge it fully before first use.

Refer to the charger's instruction manual for the details.

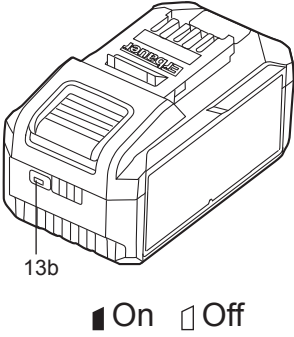
## Battery pack power bar

The Li-Ion battery pack is equipped with a power bar (10c) which is used to give an indication of the battery pack's remaining charge. Press the power bar button (10b) to check battery charge as below. The LED will stay lit for approximately 5 seconds.

	76-100% Charge	
	51-75% Charge	
	26-50% Charge	
	5-25% Charge	

# EN Functions & settings

## Intended use

This hedge trimmer ERI1027GHT is designated with a rated voltage of 36 V $\overline{\text{---}}$ . It is designed only to be used with the battery pack which is listed in the chapter of “Technical specifications”.

The product is intended for trimming hedges, bushes and shrubs. It must not be used for cutting other materials, such as plastic, stone, metal or wood that contains foreign objects. Check the hedges and bushes to be cut for foreign objects, e.g. wire fences and hidden wiring.

Do not use this product in wet or humid conditions.

For safety reasons it is essential to read the entire instruction manual before first operation and to observe all the instructions therein.

This product is intended for private domestic use only, not for any commercial trade use. It must not be used for any purposes other than those described.

Always remove the blade cover from the blade before operation.

## Adjusting the angle of the rear handle

With the blade directed away from you, always hold the trimmer with both hands. One hand on the front handle and the other hand on the rear handle.

The angle of the rear handle can be adjusted in five positions.

1. Press the head lock button (5) and hold it in position. (Fig. 3a)
2. Turn the rear handle clockwise or counterclockwise for five positions: 0° (default position), +45°, +90°, -45°, and -90°. This gives you many choices for a comfortable grip when performing trimming operations (Fig. 4c – Fig. 4).
3. Release the head lock button and turn the rear handle until it locks in place.

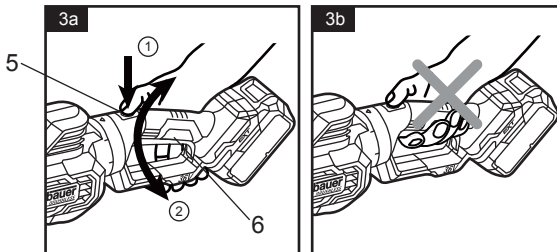

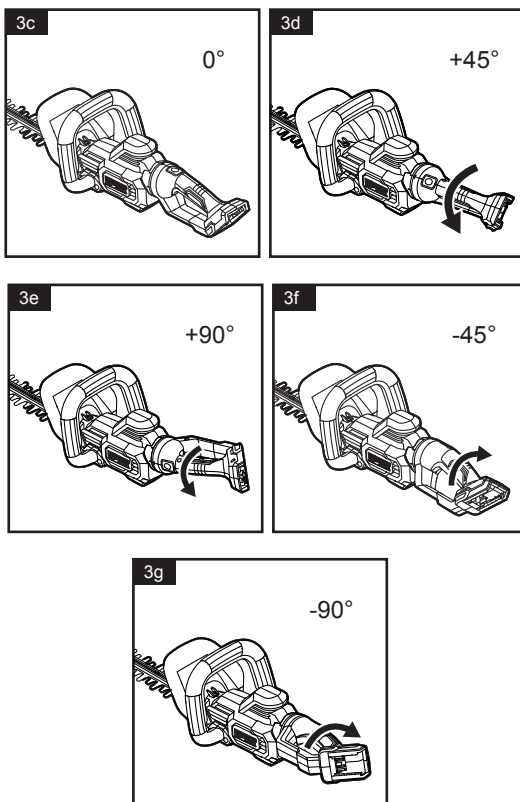

To avoid accidental starting, the rear trigger (7) will be locked in OFF position if the head lock button (5) is depressed. And if the rear trigger (7) is depressed, the head lock button (5) will be disabled.

**NOTICE:** Before operating the hedge trimmer, make sure the head lock button is popped up and the rear handle is locked in place.



**WARNING!** To avoid accidental starting, never press the rear trigger when adjusting the angle. (Fig. 3b)



**WARNING!** Do not attempt to pivot the handle while the machine is running. Stop the machine and remove the battery first.

## Switching on/off

1. Ensure the battery pack is assembled on the battery docking port (8).
2. Remove the blade cover (9) from the blade (1).
3. Ensure the blade (1) does not come into contact with anything before starting the product.
4. Squeeze and hold the front trigger (3) with one hand. Press and hold the rear trigger (3) with the other hand.



**WARNING!** Do not start the product while handling it with one hand.

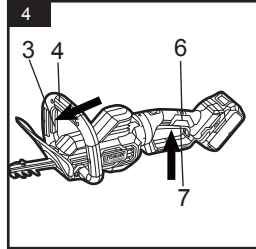

5. Move hedge trimmer away from the cutting area and release either of the triggers to stop it.



**WARNING!** The product will continue to work for some time even after the motor has been switched off! Wait until it comes to a complete stop before you put the product down!



**WARNING!** Always remove the battery pack from the hedge trimmer during work breaks and after finishing work.

# EN Operation

---

## Trimming tips



**NOTE:** While trimming, the cutting device is possible to be blocked. So the product will turn off automatically due to over current. Therefore release the on/off switch and then press down again to go on with trimming.



**WARNING!** Clear the area to be cut before each use. Remove all objects, such as cords, lights, wire, or string which can become entangled in the cutting blade and create a risk of serious personal injury.

1. Before starting the hedge trimmer, maintain proper footing and balance and do not overreach. Wear safety goggles, non-skid footwear and rubber gloves. Hold the unit with both hands with the cutting blades directed away from you.
2. Cut and remove branches exceeding the cutting capacity of this product using a proper pruner before operation.
3. Move the hedge trimmer lightly through the cutting surface in a sweeping motion following the shape of the hedge or shrub.
4. A slight tilt downwards of the cutting device in the direction of motion is recommended for optimum cutting performance.
5. Do not trim too much at once. This can cause the blades to bind and slow down, reducing the cutting efficiency.
6. Do not force the hedge trimmer through heavy shrubbery. This can cause the blades to bind and slow down. If the blades slow down, reduce the pace of your work.
7. First cut both sides from the bottom cutting upwards to the top.
8. This will prevent any of the trimmings falling into the path of the area still to be cut (Fig. 5).

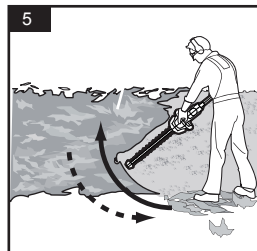

9. After cutting the sides proceed to the top. Try to keep the cutting device angled at approximately 15° to the cutting surface (Fig. 6).

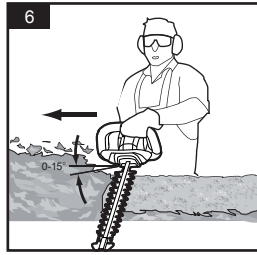

10. Cut in a number of stages if the area being cut is particularly long to achieve a better result; smaller trimmings will allow for easy composting.
11. When trimming new growth, use a wide sweeping action, so that the stems are fed directly into the cutting blade. Older growth will have thicker stems and will be trimmed most easily by using a back-and-forth motion.



**WARNING!** In some countries regulations define at what time of the day and on what special days products are allowed to be used and what restrictions apply! Ask your community for detailed information and observe the regulations in order to preserve a peaceful neighbourhood and avoid committing administrative offences!

## Operating hours

Only operate the product at reasonable hours - not early in the morning, late at night or on weekends/public holidays when people might be disturbed. Inform yourself about local restrictions.

## After use

1. Move the hedge trimmer away from cutting area, and switch the product off.
2. Remove the battery pack and let the product cool down.
3. Attach the blade cover (9) onto the blade.
4. Check, clean and store the product as described below.

# EN Care and maintenance

---

## The golden rules for care



**WARNING!** Always switch the product off, remove the battery pack and let the product cool down before performing inspection, maintenance and cleaning work!

**WARNING!** Blades are sharp. When handling the blade assembly, wear nonslip, heavy-duty protective gloves. Do not place your hand or fingers between blades or in any position where they could get pinched or cut. NEVER touch blades or service the unit with battery pack installed.

1. Keep the product clean. Remove debris from it after each use and before storage.
2. Regular and proper cleaning will help ensure safe use and prolong the life of the product.
3. Inspect the product before each use for worn and damaged parts. Do not operate it if you find broken and worn parts.
4. Maintain the rear handle at regular intervals to make sure it can pivot and be fixed in different positions.



**WARNING!** Only perform repairs and maintenance work according to these instructions! All further works must be performed by a qualified specialist!

## General cleaning

1. Make sure the product is switched off, cooled down and the battery pack is removed.
2. Clean the product with a slightly damp cloth and mild soap. Use a brush for areas that are hard to reach.
3. In particular clean the air vents (12) after every use with a cloth and brush.
4. Remove stubborn dirt with high pressure air (max. 3 bar).
5. Cleaning and maintenance before storage.



**NOTE:** Do not use chemical, alkaline, abrasive or other aggressive detergents or disinfectants to clean this product as they might be harmful to its surfaces.

6. Check for any damage and wear. Repair damages in accordance with this instruction manual or take it to an authorised service centre before using the product again.

## Lubricating the blades

For best operation and longer blade life, lubricate the blades with light-weight machine oil before and after each use.

1. Remove the battery pack.
2. Lay the hedge trimmer on a flat surface. Apply some light-weight machine oil along the edge of the top blades. If you will be using the hedge trimmer for an extended time, it is advisable to take a break, remove the battery, and oil the blades. (Fig. 7)

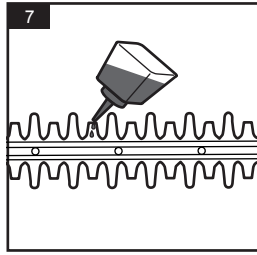

If the upper blades are aligned completely with the lower ones, start the hedge trimmer and then stop it to offset the blades before lubrication.



**WARNING!** This operation must only be performed when the blades have stopped running and the motor is switched off.

## Repair

This product does not contain any parts that can be repaired by the consumer. Contact an authorized service centre or a similarly qualified person to have it checked and repaired.

## Storage

1. Switch the product off and remove the battery pack.
2. Clean the product as described above.
3. Store the product and its accessories in a dry, frost-free, well-ventilated place.
4. Always store the product in a place that is inaccessible to children. The ideal storage temperature is between 10 and 30°C.
5. We recommend using the original package for storage to protect it against dust.



**WARNING!** Always charge the battery pack before storage! Please charge the battery pack to 3 bars on the battery light indicator. If the tool will not be used for long periods of time, charge the battery pack every 3-6 months. It is important to disconnect the charger from the power supply after charging has finished. Cool down battery pack from a just-operated product for approximately 20 minutes before attempting to recharge!

## Transportation

1. Switch the product off and remove the battery pack.
2. Attach transportation guards, if applicable.
3. Always carry the product by its rear handle.
4. Protect the product from any heavy impact or strong vibrations which may occur during transportation in vehicles.
5. Secure the product to prevent it from slipping or falling over.

## Transportation

1. Switch the product off and remove the battery pack.
2. Attach transportation guards, if applicable.
3. Always carry the product by its rear handle.
4. Protect the product from any heavy impact or strong vibrations which may occur during transportation in vehicles.
5. Secure the product to prevent it from slipping or falling over.

## Troubleshooting

Suspected malfunctions are often due to causes that the users can fix themselves. Therefore check the product using this section. In most cases the problem can be solved quickly.



**WARNING!** Only perform the steps described within these instructions! All further inspection, maintenance and repair work must be performed by an authorised service centre or a similarly qualified specialist if you cannot solve the problem yourself!

Problem	Possible cause	Solution
1. Product does not start	1.1. Battery pack is not properly attached	1.1. Attach properly
	1.2. Battery pack is discharged	1.2. Remove and charge battery pack
	1.3. Battery pack is damaged	1.3. Check by a specialist electrician
	1.4. The front and rear triggers are not depressed simultaneously.	1.4. Press the triggers in the front and rear handle simultaneously.
	1.5. The blade is jammed.	1.5. Remove the battery pack from the machine, remove the obstruction carefully, then reinsert the battery and restart the machine.
	1.6. Other electrical defect to the product	1.6. Check by a specialist electrician

2. Excessive vibration or noise	2.1. Dry or corroded blades.	2.1. Lubricate the blades, following the instructions in the “ <b>Lubricating the blade</b> ” section in this manual.
	2.2. Blades or blade support is bent.	2.2. Contact an authorized service center for blade replacement service.
	2.3. Bent or damaged teeth.	2.3. Contact an authorized service center for blade replacement service.
	2.4. Bolts/nuts are loose.	2.4. Tighten bolts/nuts
3. Product suddenly stops	3.1. Battery pack is discharged	3.1. Remove and charge battery pack
	3.2. Battery pack is too hot	3.2. Remove battery pack and let it cool down
	3.3. Cutting device is blocked	3.3. Remove blockage

## Recycling and disposal



Waste electrical products should not be disposed of with household waste. Please recycle where facilities exist. Check with your Local Authority or local store for recycling advice.

For further information visit [www.recycle-more.co.uk](http://www.recycle-more.co.uk).

The product comes in a package that protects it against damage during shipping. Keep the package until you are sure that all parts have been delivered and the product is working properly. Recycle the package afterwards.

## Disposal of an exhausted battery pack



The battery is Li-Ion type. To preserve natural resources, please recycle or dispose of the battery pack properly. Consult your local waste authority for information regarding available recycling and / or disposal options.

Discharge your battery pack by operating your tool, then remove the battery pack from the tool and cover the battery pack connections with heavy duty adhesive tape to prevent short circuit and energy discharge.

Do not attempt to open or remove any of the components.

# EN Guarantee

---

At **Erbauer** we take special care to select high quality materials and use manufacturing techniques that allow us to create ranges of products incorporating design and durability.

We carry out stringent testing procedures on all our tools and are confident that they can provide regular, sustained daily use during the period covered.

This power tool is guaranteed for 3 years from the date of purchase, if bought in store, delivered or bought online. You may only make a claim under this guarantee upon presentation of your sales receipt or purchase invoice. Please keep your proof of purchase in a safe place.

This guarantee covers product failures and malfunctions provided the **Erbauer** power tool was used for the purpose for which it is intended and subject to installation, cleaning, care and maintenance in accordance with standard practice and with the information contained above and in the user manual. This guarantee does not cover defects and damage caused by or resulting from:

- Normal wear and tear
- Overload, misuse or neglect
- Repairs attempted by anyone other than an authorized agent
- Cosmetic damage
- Damage caused by foreign objects, substances or accidents
- Accidental damage or modification
- Failure to follow manufacturer's guidelines
- Loss of use of the goods

This guarantee is limited to parts recognised as defective. It does not, in any case, cover ancillary costs (movement, labour) and direct and indirect damage. If the **Erbauer** power tool is defective during the guarantee period, then we reserve the right, at our discretion, to replace the item with a product of equivalent quality and functionality or to provide a refund.

This guarantee only applies to the country of purchase or delivery and is not transferrable to any other countries. This guarantee is non-transferrable to any other person or product. Relevant local law will apply to this guarantee.

Guarantee related queries should be addressed to a store affiliated with the distributor from where you purchased the **Erbauer** power tool.

**Erbauer** battery and charger are guaranteed for 2 years and covered by all others terms within the above guarantee.

This guarantee is in addition to and does not affect your statutory rights relating to faulty goods as a consumer.

## **Manufacturer:**

Kingfisher International Products Limited  
1 Paddington Square, London, W2 1GG, United Kingdom [www.kingfisher.com/products](http://www.kingfisher.com/products)

## **Distributor:**

B&Q plc  
Chandlers Ford, Hants, SO53 3LE, United Kingdom  
[www.diy.com](http://www.diy.com)

Screwfix Direct Limited  
Trade House, Mead Avenue, Yeovil, BA22 8RT, United Kingdom  
[www.screwfix.com](http://www.screwfix.com)

**IMPORTANT - RETAIN THIS  
INFORMATION FOR FUTURE  
REFERENCE: READ CAREFULLY**

# EN Customer care and technical helpline

---

## A better way to repair your tools

Kingfisher takes special care in creating high-quality garden power tools that are designed to last. But if a fault develops with your garden power tool and you need to claim under the guarantee, the Customer Care and Technical Helpline can support with technical assistance or if required, arrange a free courier collection from your home, assess your garden power tool for fault, repair it, and return it.

Deciding to repair your product rather than buying a replacement and adding to the mountain of waste is a more sustainable choice and you will be doing your bit for the environment.

## How does it work?



**NOTE:** Before collection, all fuel must be removed from petrol powered machines.

## Get in touch

If you need help or more information, please contact the Customer Care and Technical Helpline:

UK 0330 678 3077

ROI 1 800 365 800

Opening hours are Monday – Friday, 8am-5pm

## Availability of spare parts

Contact the customer service helpline for assistance or visit [www.kingfishersparses.com](http://www.kingfishersparses.com)

For assistance contact the customer services helpline:

UK 0800 0789647 [uk@kingfisherservice.com](mailto:uk@kingfisherservice.com)

EIRE 1800 932226 [eire@kingfisherservice.com](mailto:eire@kingfisherservice.com)

Further information about this product can also be found at:

[www.kingfisher.com/products](http://www.kingfisher.com/products)



# EN Declaration of conformity



**(EN) EU DECLARATION OF CONFORMITY**  
**(FR) DÉCLARATION UE DE CONFORMITÉ**  
**(PL) DEKLARACJA ZGODNOŚCI UE**  
**(RO) DECLARAȚIA DE CONFORMITATE UE**  
**(ES) DECLARACIÓN UE DE CONFORMIDAD**  
**(PT) DECLARAÇÃO DE CONFORMIDADE UE**

Product/ Produit/ Produkt/Produsul/Producto/Produto

•Cordless Hedge Trimmer/ Taille-Haie Sans Fil/ Bezprzewodowe Nożyce Do Żywopłotu/ Trimmer Pentru Gard Viu Fără Fir/ Cortasetos Inalámbrico/ Corta Sebes Sem Fios  
•83009/ERT1027GHT  
•Serial number 00001-99999

Name and address of the manufacturer or his authorised representative:

Nom et adresse du fabricant ou de son mandataire:

Nazwa i adres producenta lub jego upoważnionego przedstawiciela:

Denumirea și adresa producătorului sau a reprezentantului său autorizat:

Nombre y dirección del fabricante o de su representante autorizado:

Nome e endereço do fabricante ou do respetivo mandatário:

Kingfisher International Products B.V.,  
Rapenburgerstraat 175E,  
1011 VM Amsterdam,  
The Netherlands

This declaration of conformity is issued under the sole responsibility of the manufacturer.

La présente déclaration de conformité est établie sous la seule responsabilité du fabricant. Niniejsza deklaracja zgodności wydana zostaje na wyłączną odpowiedzialność producenta. Prezenta declarație de conformitate este emisă pe răspunderea exclusivă a producătorului.

La presente declaración de conformidad se expide bajo la exclusiva responsabilidad del fabricante.

A presente declaração de conformidade é emitida sob a exclusiva responsabilidade do fabricante.

Object of the declaration/ Objet de la déclaration/ Przedmiot deklaracji/ Obiectul declarației/ Objeto de la declaración/ Objeto da declaração

Product/ Produit/ Produkt/Produsul/ Producto/  
Produto

Cordless Hedge Trimmer/ Taille-Haie Sans Fil/  
Bezprzewodowe Nożyce Do Żywopłotu/ Trimmer  
Pentru Gard Viu Fără Fir/ Cortasetos Inalámbrico/  
Corta Sebes Sem Fios

Model/ Modèle/ Model/ Modelul/ Modelo/ Modelo

83009/ERT1027GHT

The object of the declaration described above is in conformity with the relevant Union harmonisation legislation:

L'objet de la déclaration décrit ci-dessus est conforme à la législation d'harmonisation de l'Union applicable:

Wymieniony powyżej przedmiot niniejszej deklaracji jest zgodny z odpowiednimi wymaganiami unijnego prawodawstwa harmonizacyjnego:

Obiectul declarației descris mai sus este în conformitate cu legislația relevantă de armonizare a Uniunii:

El objeto de la declaración descrita anteriormente es conforme con la legislación de armonización pertinente de la Unión:

O objeto da declaração acima descrito está em conformidade com a legislação de harmonização da União aplicável:

2006/42/EC as amended	Machinery Directive
2014/30/EU as amended	Directive Electromagnetic compatibility
2000/14/EC as amended	Outdoor Noise Directive
2011/65/EU as amended	Directive Restriction of the use of certain hazardous substances in electrical and electronic equipment
Directive 2006/42/CE relative aux machines	
2014/30 / UE telle que modifiée	Directive Compatibilit�� electromagn��tique
Directive 2000/14/CE relative aux ��missions sonores ext��rieures	
Directive 2011/65/UE relative �� la limitation de l'utilisation de certaines substances dangereuses dans les ��quipements ��lectriques et ��lectroniques	
2006/42/WE w zmienionej dyrektywie maszynowej	
2014/30 / UE ze zmianami	Dyrektywa Kompatybilno�� elektromagnetyczna
2000/14/WE w zmienionej dyrektywie w sprawie ha��su na zewn��trz	
2011/65 / UE ze zmianami	Dyrektywa Ograniczenie stosowania niektórych niebezpiecznych substancji w sprz��cie elektrycznym i elektronicznym
2006/42/CE, astfel a fost modificat��	Directiva privind echipamentele
2014/30/UE, astfel a fost modificat��	Directiva privind compatibilitatea electromagnetic��
2000/14/CE, astfel a fost modificat��	Directiva privind zgomotul ��n aer liber
2011/65/UE, astfel a fost modificat��	Directiva privind limitarea utiliz��rii anumitor substan��e periculoase ��n echipamentele electrice ��i electronice
Directiva sobre maquinaria modificada 2006/42/CE	
2014/30/UE modificada	Directiva Compatibilidad electromagn��tica
2000/14/CE modificada	Directiva sobre ruido al aire libre
2011/65/UE modificada	Directiva Restricci��n del uso de determinadas sustancias peligrosas en equipos el��ctricos y electr��nicos
2006/42/CE como diretiva de m��quinas alteradas	
2014/30/UE como altera��o da compatibilidade eletromagn��tica	
2000/14/CE como diretiva de ru��do exterior alterada	
2011/65/UE como restri��o diretiva alterada da utiliza��o de certas subst��ncias perigosas em equipamentos el��tricos e eletr��nicos	
Measured Sound Power Level	Guaranteed Sound Power Level
Le niveau de puissance acoustique mesur��	Le niveau de puissance acoustique garant
Zmierzony poziom mocy akustycznej	Gwarantowany poziom mocy akustycznej
Nivel de putere acustic�� m��surat	Nivel de putere acustic�� garantat
Nivel de potencia sonora medido	Nivel de potencia sonora garantizado
N��vel de pot��ncia sonora medido: 90 dB(A)	N��vel de pot��ncia sonora garantido: 92 dB(A)
References to the relevant harmonised standards used or references to the other technical specifications in relation to which conformity is declared:	
R��f��rences des normes harmonis��es pertinentes appliqu��es, y compris la date de celles-ci, ou des autres caract��ristiques techniques, y compris la date de celles-ci, par rapport auxquelles la conformit�� est d��clar��e:	
Odwolania do odno��nych norm zharmonizowanych, kt��re zastosowano, wraz z dat�� normy, lub do innych specyfikacji technicznych, wraz z dat�� specyfikacji, w odniesieniu do kt��rych deklarowana jest zgodno��c:	
EN 62841-1:2015+A11:2022;	
EN 62841-4-2:2019+A1:2022+A11:2022	
EN IEC 55014-1:2021	
EN IEC 55014-2:2021	

Authorised signatory and technical file holder/signataire et responsable de la documentation technique  
authorisé/ podmiot uprawniony do wystawienia i adres prezechowywania dokumentacji technicznej/  
semnatar autorizat și deținător al dosarului tehnic/firmante autorizado y titular del expediente técnico/  
signatário autorizado e detentor da ficha técnica

Kingfisher International Products B.V.,  
Rapenburgerstraat 175E,  
1011 VM Amsterdam,  
The Netherlands

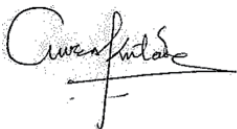
A handwritten signature in black ink, appearing to read 'David Awe', with a long horizontal stroke extending to the right.

David Awe  
Group Quality Director

30/07/2024



## (UK) DECLARATION OF CONFORMITY

### Product

- Cordless Hedge Trimmer
- 83009/ERT1027GHT
- Serial number 00001-99999

### Name and address of the manufacturer or his authorised representative:

Kingfisher International Products Limited  
1 Paddington Square  
London  
W2 1GG  
United Kingdom

This declaration of conformity is issued under the sole responsibility of the manufacturer.

### Object of the declaration

#### Product

Cordless Hedge Trimmer

#### Model

83009/ERT1027GHT

### The object of the declaration described above is in conformity with the relevant legislation:

2006/42/EC as amended	Machinery Directive
2014/30/EU as amended	Directive Electromagnetic compatibility
2000/14/EC as amended	Outdoor Noise Directive
2011/65/EU as amended	Directive Restriction of the use of certain hazardous substances in electrical and electronic equipment

Measured Sound Power Level: 90 dB(A)

Guaranteed Sound Power Level: 92 dB(A)

### References to the relevant designated standards used or references to the other technical specifications in relation to which conformity is declared:

EN 62841-1:2015+A11:2022;	EN IEC 55014-1:2021
EN 62841-4-2: 2019+A1:2022+A11:2022	EN IEC 55014-2:2021
BS EN 62841-1:2015+A11:2022	BS EN IEC 55014-1:2021
BS EN 62841-4-2: 2022	BS EN IEC 55014-2:2021

### Authorised signatory and technical file holder:

Kingfisher International Products Limited  
1 Paddington Square  
London  
W2 1GG  
United Kingdom

David Awe  
Group Quality Director

On:30/07/2024







---

**Manufacturer :**

**UK Manufacturer:**

Kingfisher International Products Limited,  
1 Paddington Square, London, W2 1GG,  
United Kingdom

**EU Manufacturer:**

Kingfisher International Products B.V.  
Rapenburgerstraat 175E  
1011 VM Amsterdam  
The Netherlands

**EN** [www.diy.com](http://www.diy.com)

[www.screwfix.com](http://www.screwfix.com)

[www.screwfix.ie](http://www.screwfix.ie)

**To view instruction manuals online,  
visit [www.kingfisher.com/products](http://www.kingfisher.com/products)**